



Always Supplying Advanced Flexible Excellence

iFlex RackGuard



A-SAFE iFlex RackGuard front view.

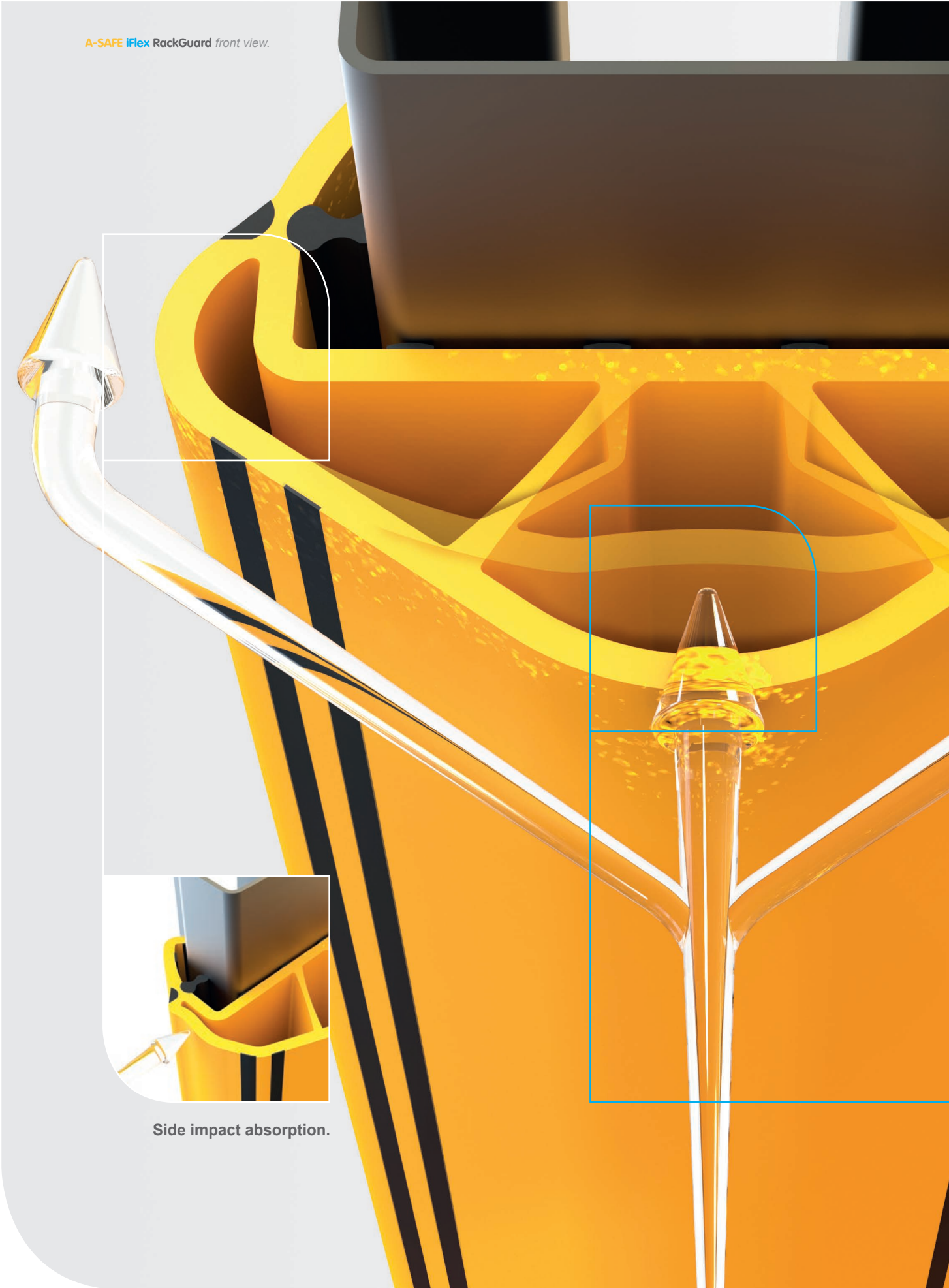

Side impact absorption.



WHY CHOOSE THE iFlex RackGuard?

Protecting racking in your workplace is vital. Choosing the right sort of protection is equally important, and we have launched the new **iFlex RackGuard** which is the best rack leg protector that you can buy. It performs.

A scientific design that brings with it a host of unique benefits, if you have racking, you need the RackGuard.

Side impact absorption.

If struck from the side, the impact energy is absorbed and the guard then reforms to its original shape.

Front impact absorption.

When hit from the front the guard reduces the impact and transfers the energy around the rack leg rather than through it, reducing damage.



Front impact absorption.

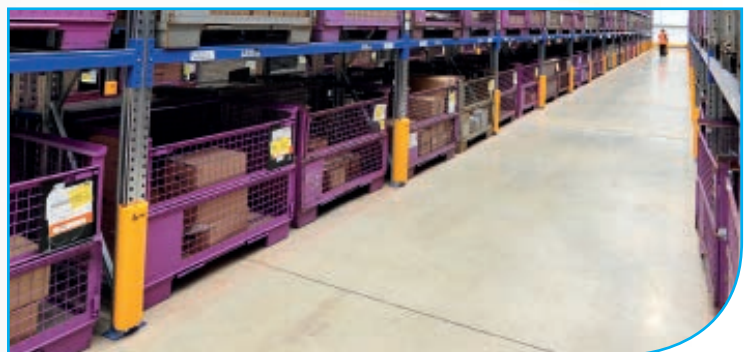

BMW parts warehouse - (Northampton UK).

A-SAFE iFlex RackGuard back view.

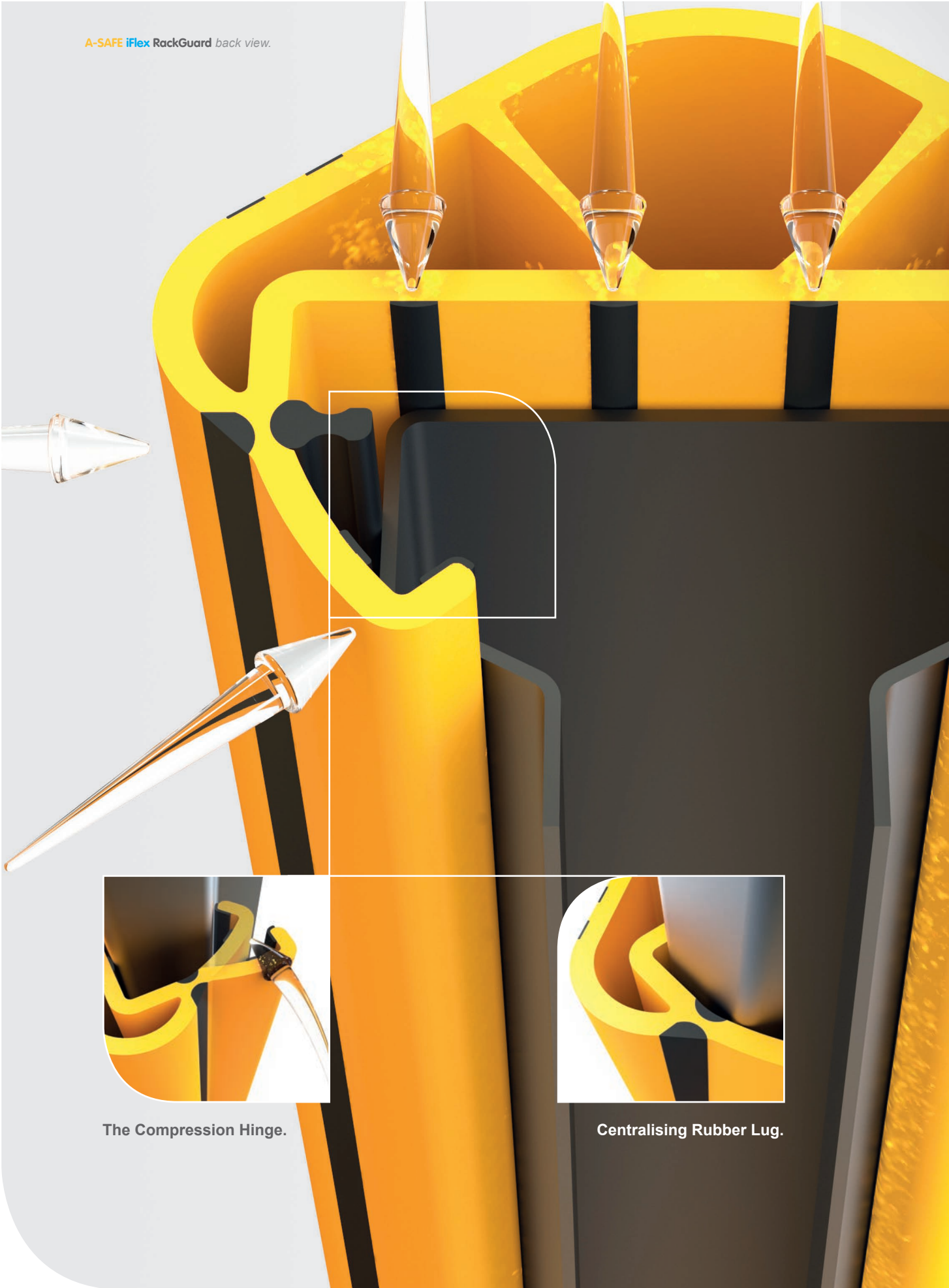

The Compression Hinge.

Centralising Rubber Lug.

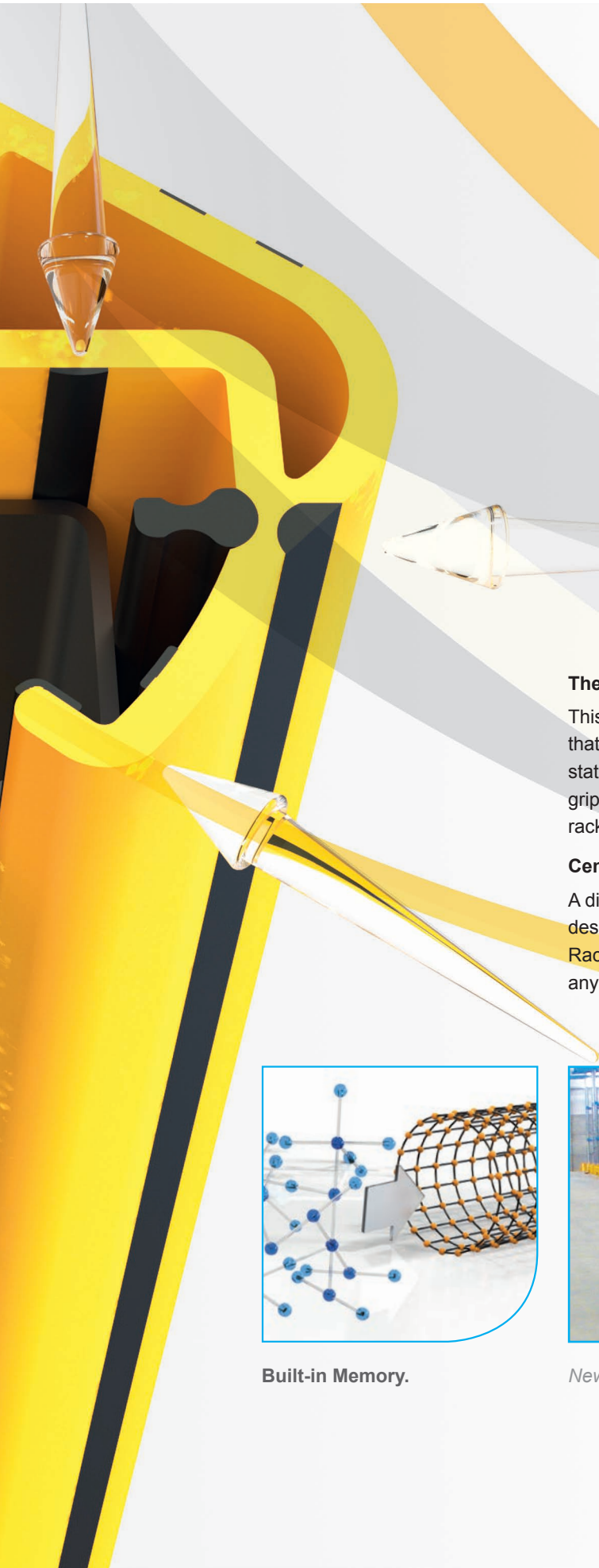

The Compression Hinge.

This unique feature ensures that the leg is in a constant state of compression and grips securely around the racking leg.

Centralising Rubber Lug.

A distinctive benefit, specially designed to ensure the RackGuard fits central to any sized rack leg.

Built-in Memory.

Made from our exclusive material, **Memaplex**, this strong and flexible product allows it to return to its original shape after impact time and time again.

Various leg lengths & sizes.

Whatever your rack leg size, our RackGuard will fit.

Ten Frictional Grip Points.

For an improved overall grip to any rack leg.

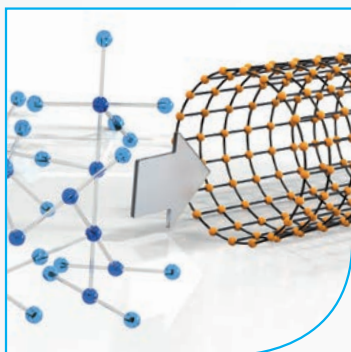

Built-in Memory.

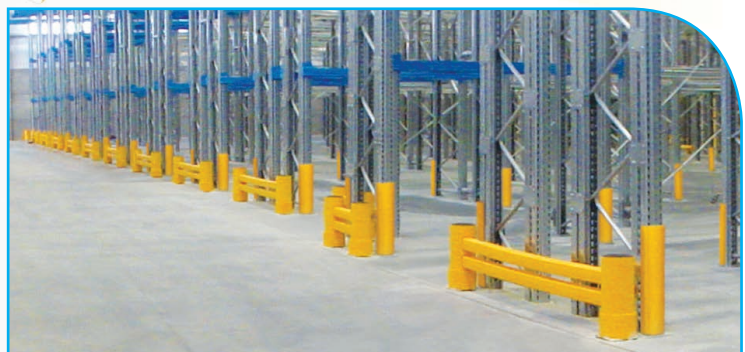

New warehouse installation.

A-SAFE on-site vertical testing rig.

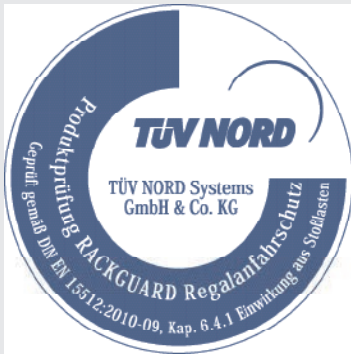

TÜV doubled the test load to 800 Newtons. The level of deflection was well within the requirements for EN 15 512. With the RackGuard you get a product that absorbs twice the force, and is twice as good.





TESTED TO THE MAXIMUM

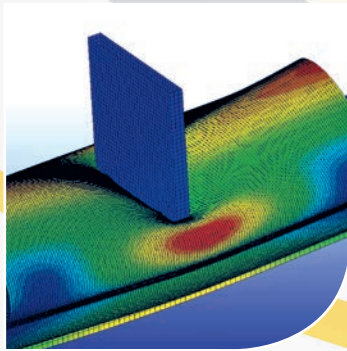

Finite Element Analysis (FEA) is a computer based method of analysing the behaviour of engineering structures and components under a variety of controlled conditions.

The **iFlex** RackGuard has undergone rigorous testing.

After spending hundreds of hours on FEA testing, we made the prototype on which to perform physical tests.

For the physical test, we mounted the RackGuard to a medium duty steel racking upright. We perform a front impact drop test where 100kg weight is dropped from one meter height resulting in a velocity of 9.8m/s. This generates a force of 1000 newtons, equivalent to a 2 tonne vehicle travelling at 3.6kmph.

Additional tests showed zero deflection on the racking after five front impacts of 400 newtons, giving you five times the safety factor.

The **iFlex** RackGuard also comes to you with independent approval that guarantees your peace of mind. It is TÜV certified to EN 15 512 standard. It has also achieved the protection outlined in the FEM 10.2.02 standard, and the AS 4084 (Australia) standard. TÜV also approve our in-house testing apparatus.



Prodinge Packaging - (Germany).

Typical damaged racking.

1



2



The iFlex RackGuard protects your warehouse by absorbing accident impacts and preventing rack legs from weakening.

3



4





MAINTAINING HIGHER STANDARDS

Did you know that, under current codes of practice:

- The maximum amount of front deflection allowed on a rack leg is 3mm.
- The maximum amount of side deflection allowed on a rack leg is 5mm

It is also common sense that, where racking is likely to be struck by lift trucks and other vehicles, it should be protected.

Generally, such damage is at the lower levels of the racking – and governing bodies all over the world recommend:

- Using renewable column guards to minimise the risk of damage from accidental impact.
- Corner uprights in a run of racking should be suitably provided with a protective device in a conspicuous colour as they are particularly high-risk.



Schneider Electronics new warehouse full installation - (France).

The **iFlex RackGuard** has been tested to ensure that you're protected against forbidden levels of deflection, and is independently tested and certified to EN 15 512 and FEM 10.2.02, and achieves the protection outlined in the AS 4084 (Australia) standard.

iFlex RackGuard

MEMAPLEX™
MEMAPLEX™_{FR}

- The **iFlex** RackGuard is available in a range of sizes, made from **Memaplex** and comes with unique hinged legs – allowing them to fix securely to any type of racking system.

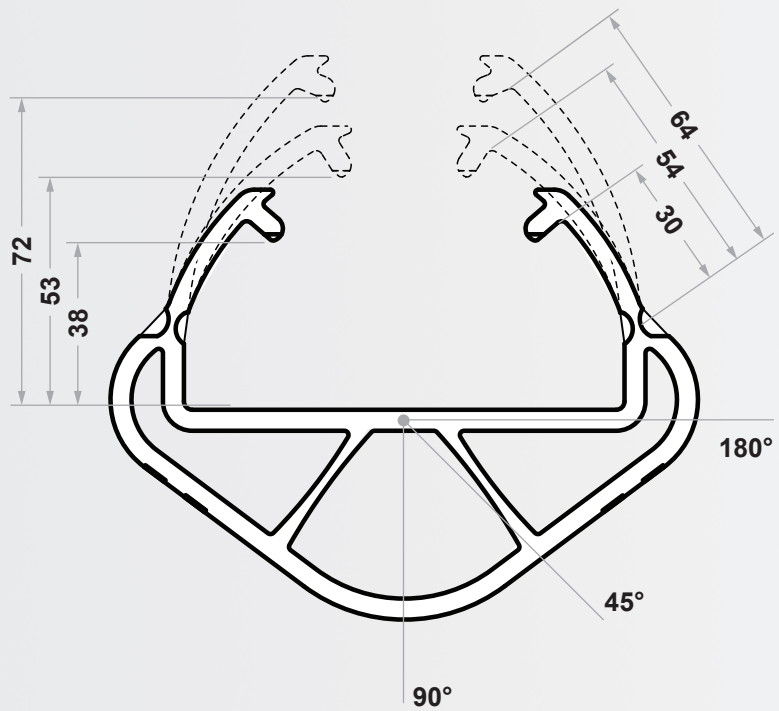
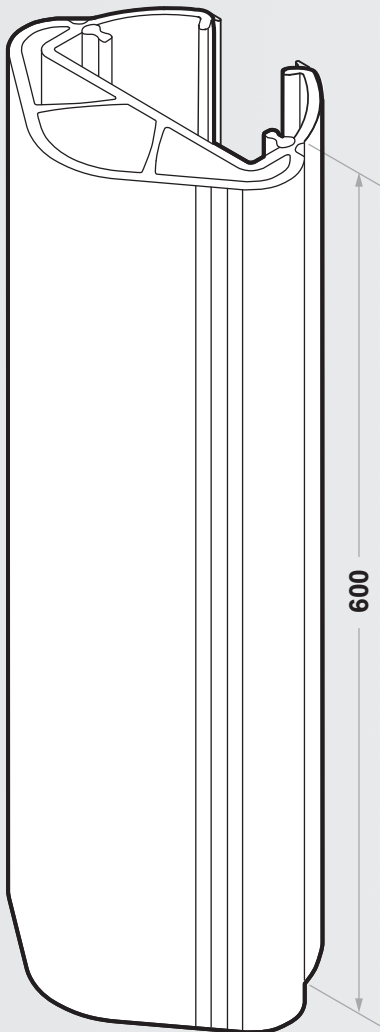
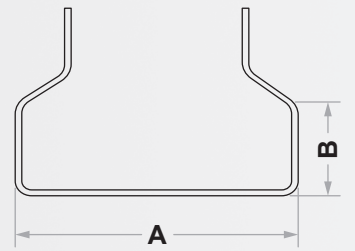
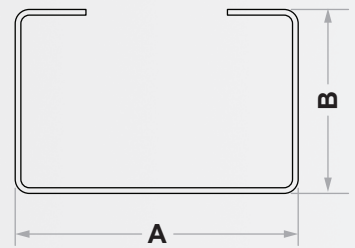
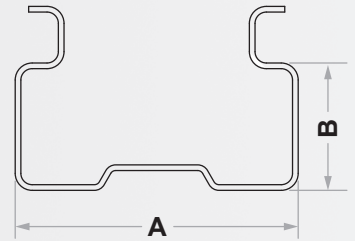



Angle of impact		45°	90°	180°
Tested impact energy (Joules)		800	1000	800
Equivalent vehicle weight (kg)		2000	2000	2000
Equivalent vehicle speed (kmph)		3.2	3.6	3.2

Material Properties		
Temperature	MEMAPLEX™	-15°C to +50°C
Temperature	MEMAPLEX®	-40°C to +30°C
Chemical Resistance		Excellent - ISO / TR 10358
Fire Rating		HB / F
Food Contact		Yes
Toxicity		None
Conductivity		No
Environment		
CO ₂ / m		3.57
Recyclability		100%

Terms and conditions apply.
Standard Warranty 2 years.

Part No.	Description	A - Rack width (max)	B - Rack depth (max)
P-03-01-0017	iFlex RackGuard (S) SL - 600mm	102	45
P-03-01-0021	iFlex RackGuard (S) ML - 600mm	102	68
P-03-01-0025	iFlex RackGuard (S) LL - 600mm	102	80
P-03-01-0018	iFlex RackGuard (S) SLR - 600mm	85	45
P-03-01-0022	iFlex RackGuard (S) MLR - 600mm	85	68
P-03-01-0026	iFlex RackGuard (S) LLR - 600mm	85	80
P-03-01-0029	iFlex RackGuard (L) SL - 600mm	126	75
P-03-01-0030	iFlex RackGuard (L) SLR - 600mm	112	75
S-01-02-0011	RackGuard Tool Set		

Optional Extras

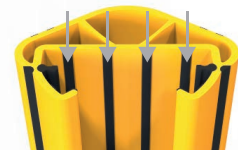

Internal Rubber Grips



RackGuard Tool Set

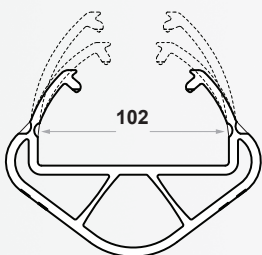
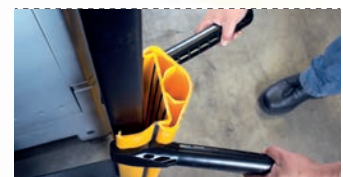

P-03-01-0017
P-03-01-0021
P-03-01-0025

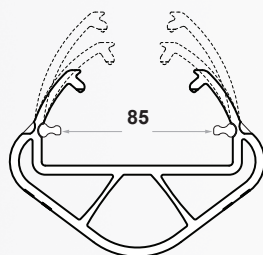

P-03-01-0018
P-03-01-0022
P-03-01-0026

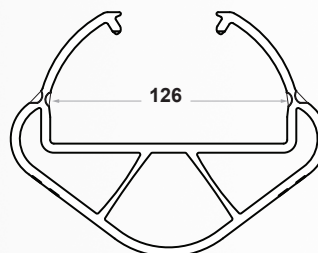

P-03-01-0029

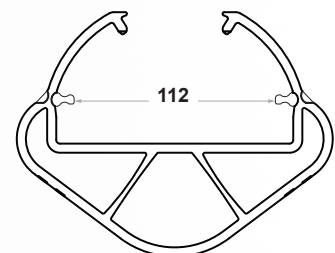











P-03-01-0030

* iFlex RackGuards are also available in 400mm, 1000mm and bespoke sizes, as well as with internal rubber lugs. All iFlex RackGuards are available in the Memaplex FR option.



Always Supplying Advanced Flexible Excellence

- | | | |
|---|------------------------|--|
|  | A-Safe (UK) Ltd | United Kingdom, Head Office |
|  | A-Safe GmbH | Germany, Austria, Switzerland |
|  | A-Safe SAS | France, Suisse Romande, Belgique (Wallonie) |
|  | A-Safe, Inc. | United States of America |
|  | A-Safe Pty Ltd | Australia |
|  | A-Safe Portugal | Portugal |
|  | A-Safe (2013) Thailand | Thailand |
|  | A-Safe APS | Scandinavian Region, Denmark, Sweden, Norway |
|  | A-Safe BV | Benelux Region, Belgium, Netherlands, Luxembourg |
|  | A-Safe Italia srl | Italy |

A-SAFE (UK) Ltd

Habergham Works, Ainleys Industrial Estate, Elland, Halifax HX5 9JP

Sales: +44 (0) 1422 331133 Enquiries: +44 (0) 1422 344402 F: +44 (0) 1422 323533

E: sales@asafe.com W: www.asafe.com



iflex RackGuard